

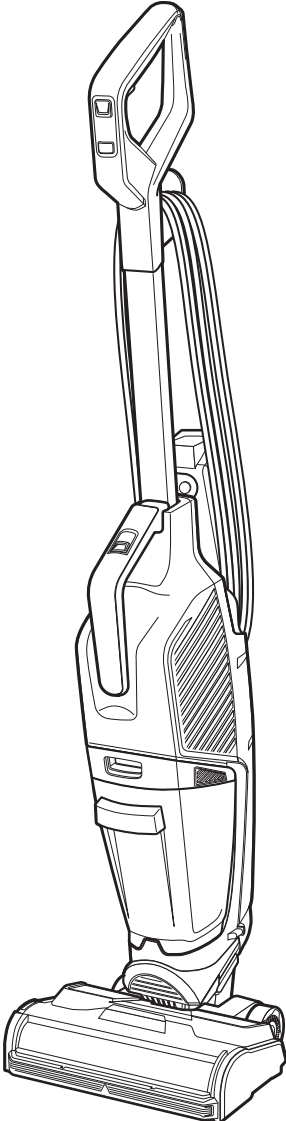

BISSELL®

CROSSWAVE® HYDROSTEAM™
3517, 3527, 3528 SERIES

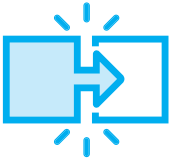



..... 4



..... 5



..... 6



..... 8



..... 9



..... 10

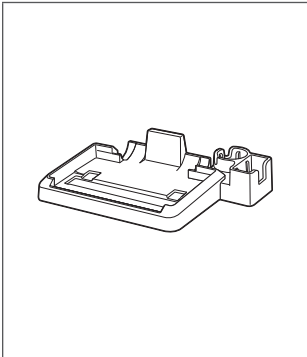
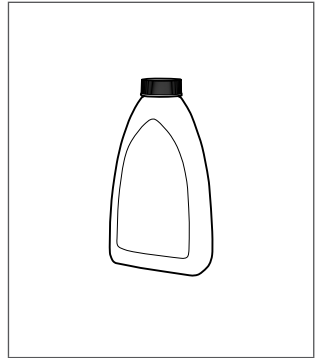
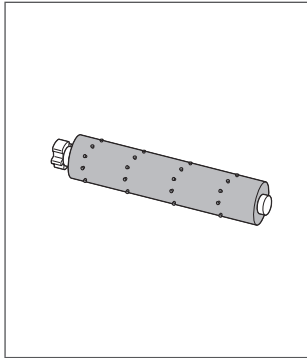
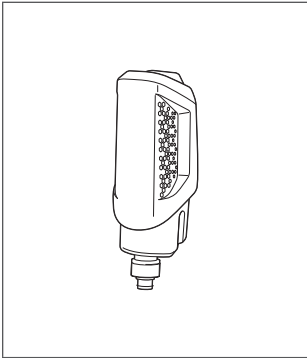
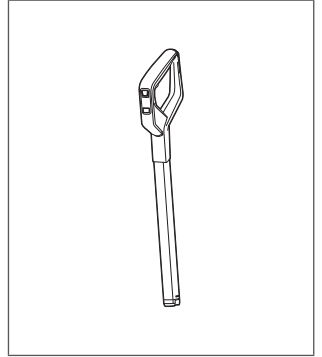
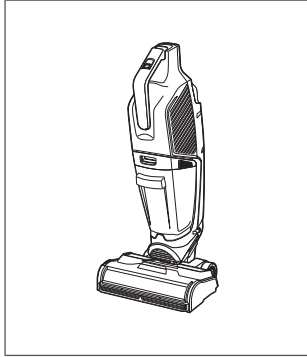

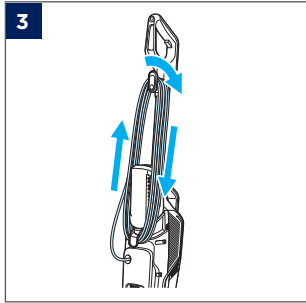
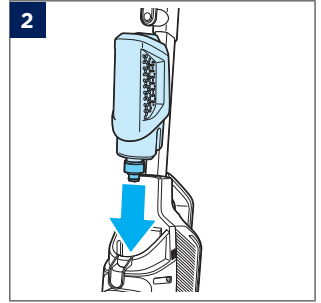
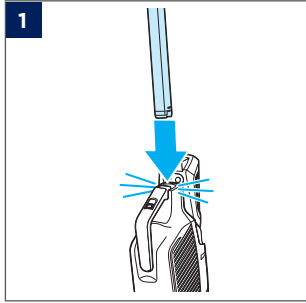
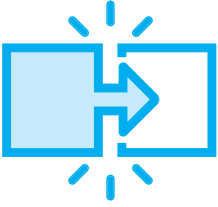

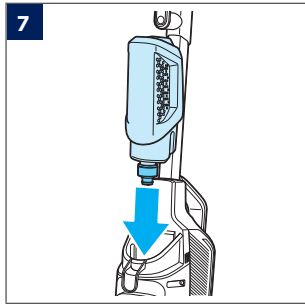
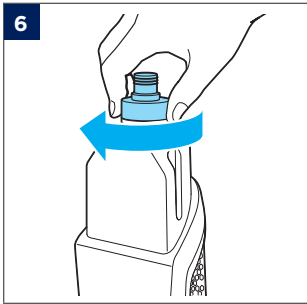
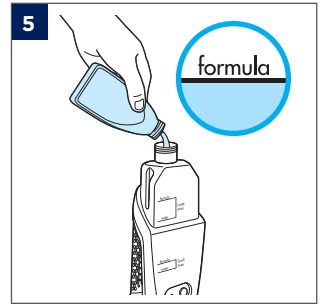
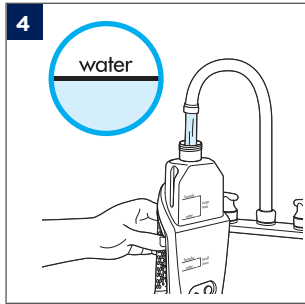
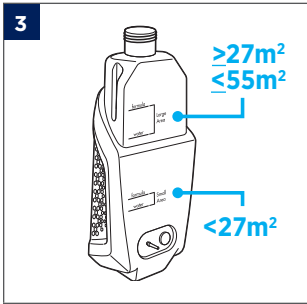
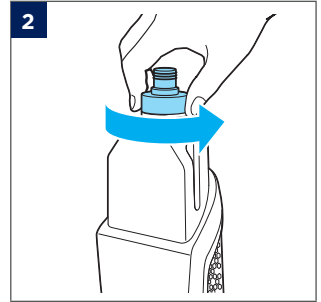
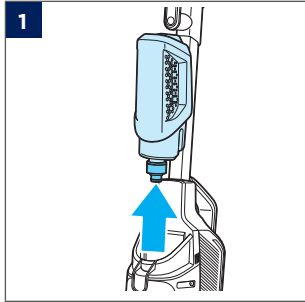

Natural Multi-Surface Cleaning Solution, Natural Multi-Surface Pet Cleaning Solution, Multi-Surface Cleaning Solution, Multi-Surface Pet Cleaning Solution, Wood Floor Cleaning Solution

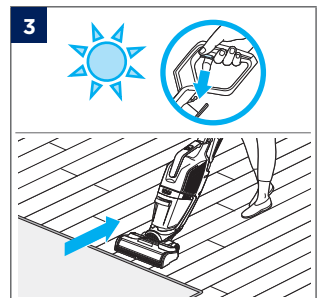
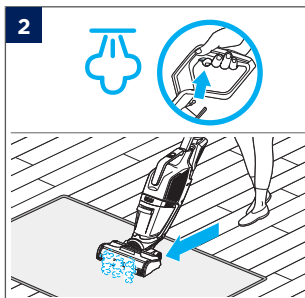
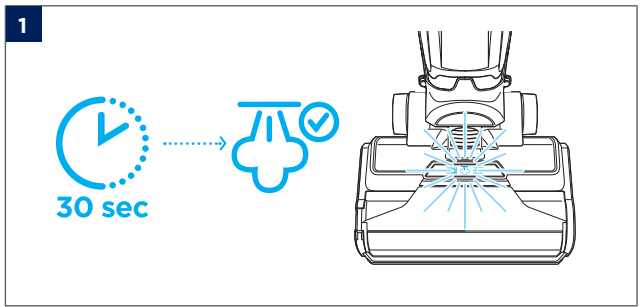
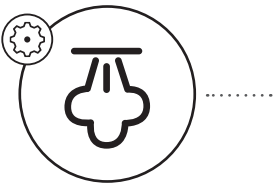
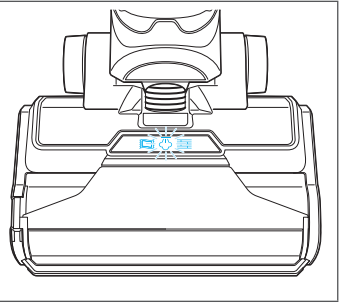
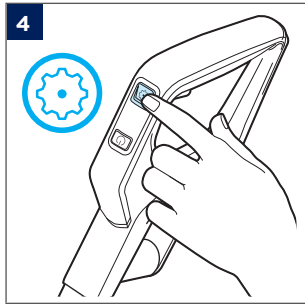
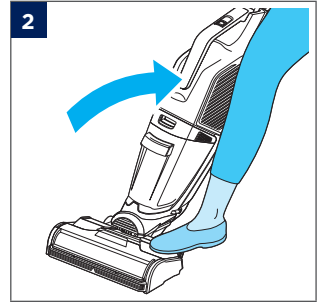
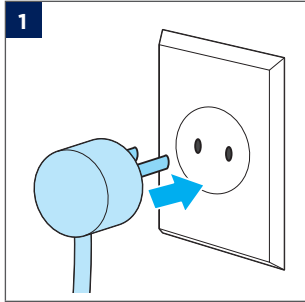

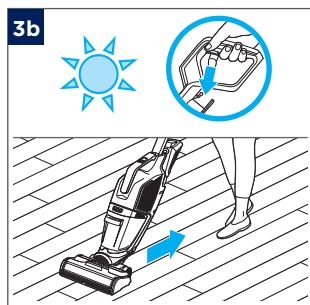
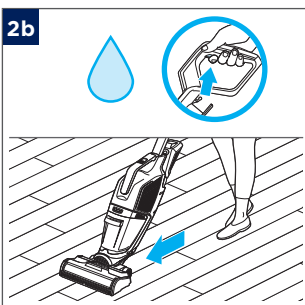
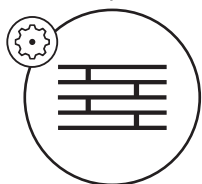
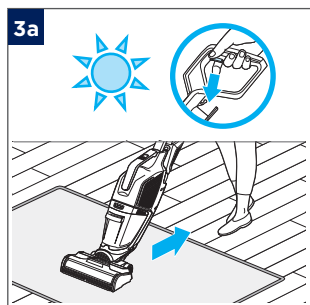
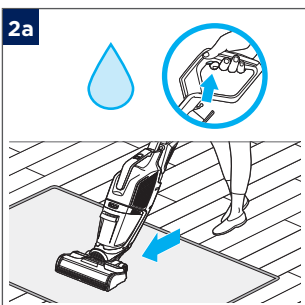
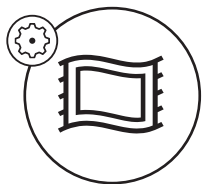
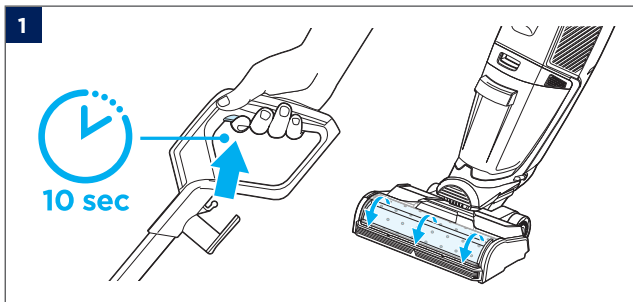

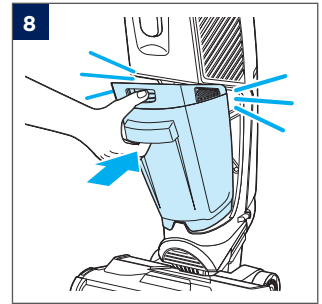
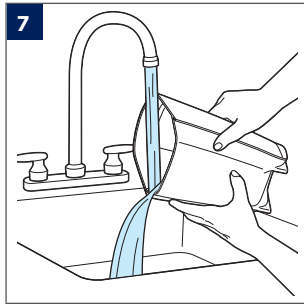
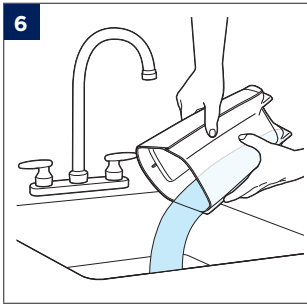
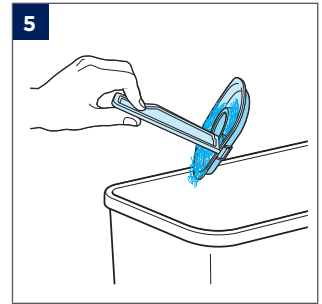
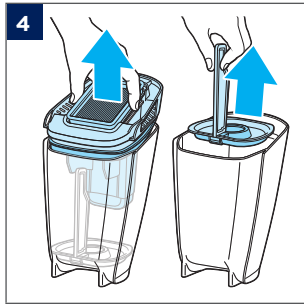
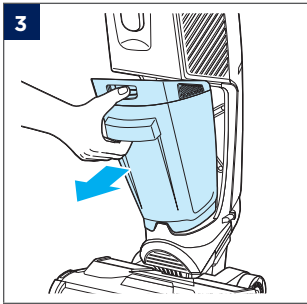
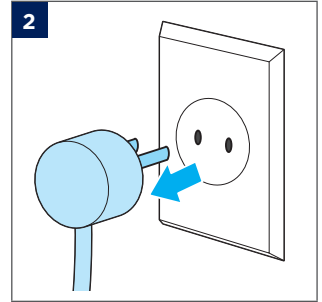
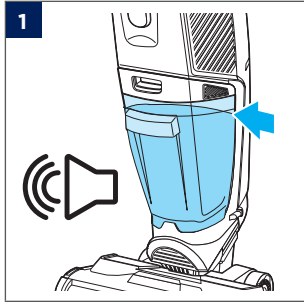

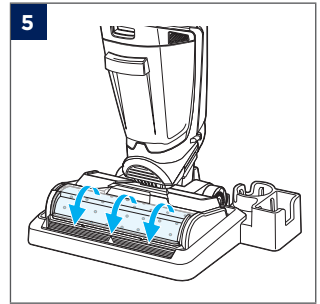
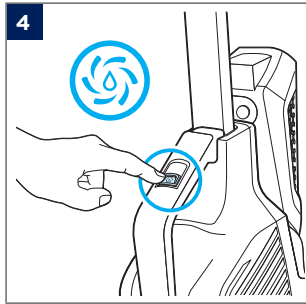
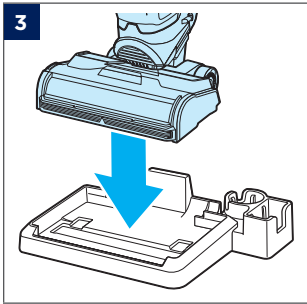
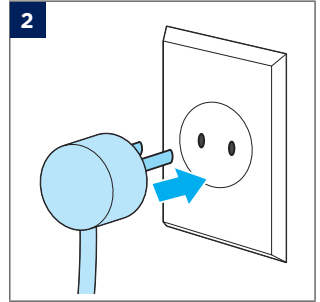
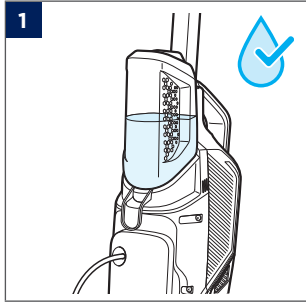

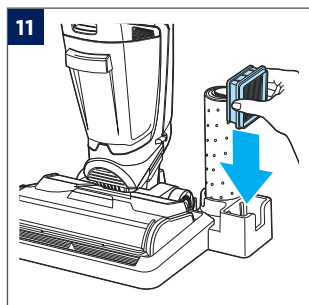
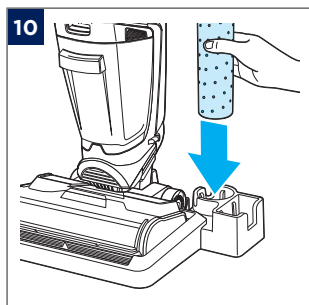
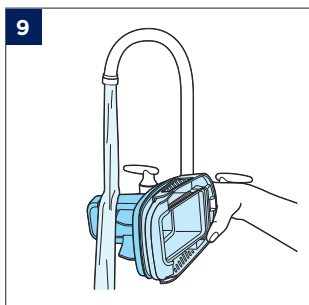
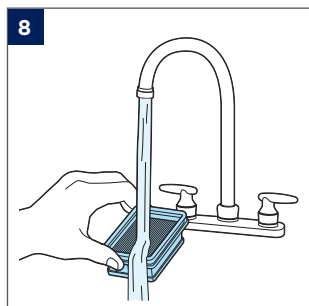
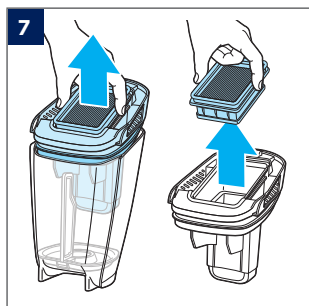
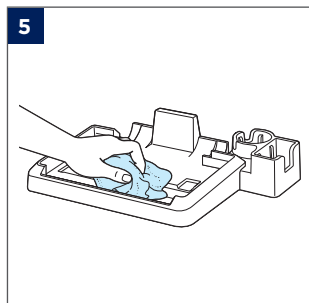
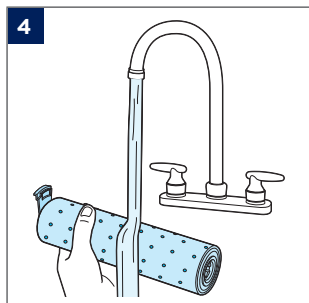
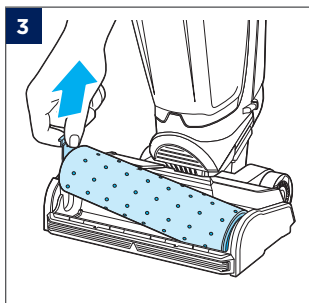
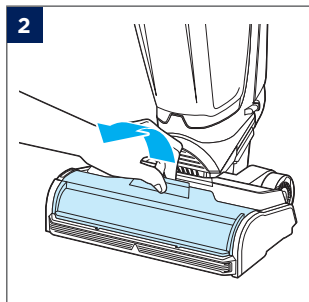
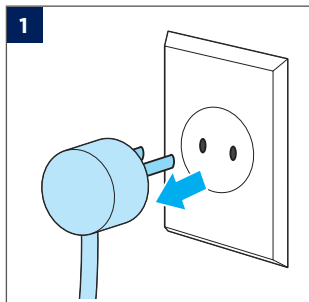

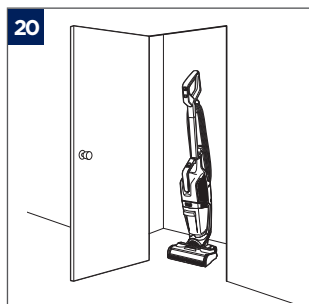
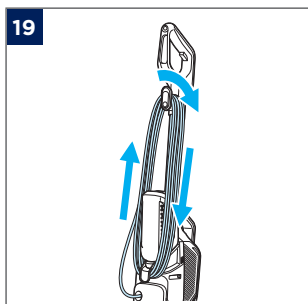
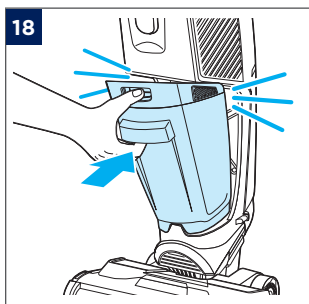
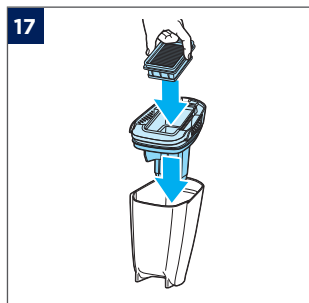
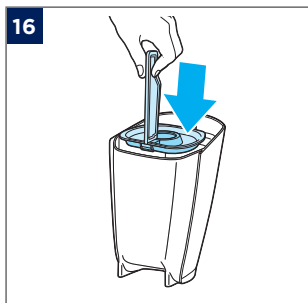
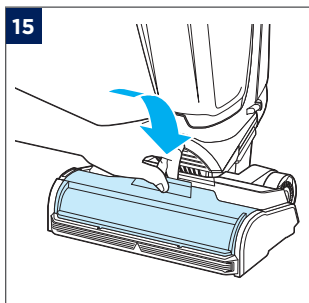
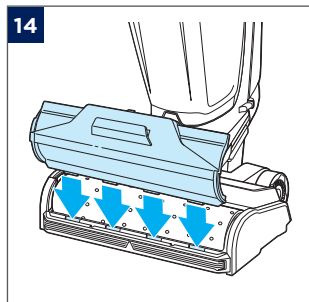
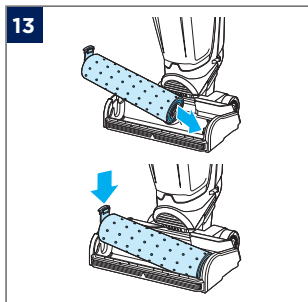
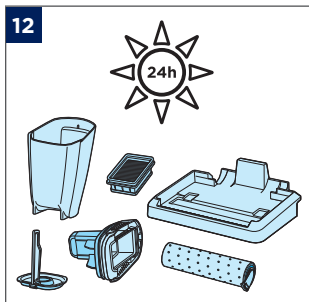
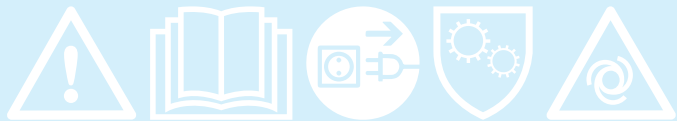



©2024 BISSELL Inc. All rights reserved.
Part Number 1642434 01/24 v18
global.BISSELL.com